

# **Operator's manual**

# **K960 Chain**

Please read the operator's manual carefully and make sure you understand the instructions before using the machine. It is the owner's responsibility to make sure that any person who use this power cutter have read this manual!

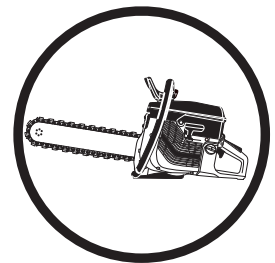

**English**

# KEY TO SYMBOLS

## Symbols on the machine:

**WARNING!** The machine can be a dangerous tool if used incorrectly or carelessly, which can cause serious or fatal injury to the operator or others.



Please read the operator's manual carefully and make sure you understand the instructions before using the machine.



Always wear:

- Protective helmet
- Hearing protection
- Protective goggles or a visor
- Breathing mask



**WARNING!** Dust forms when cutting, this can cause injuries if inhaled. Use an approved breathing mask. Avoid inhaling petrol fumes and exhaust fumes. Always provide for good ventilation.



**WARNING!** Kickbacks can be sudden, rapid and violent and can cause life threatening injuries. Read and understand the instructions in the manual before using the machine.



**WARNING!** Sparks from the cutting blade can cause fire in combustible materials such as: petrol (gas), wood, dry grass etc.



## Symbols in the operator's manual:

Switch off the engine by moving the stop switch to the STOP position before carrying out any checks or maintenance.

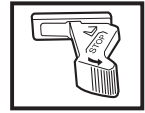

Run position.



Stop, with the return spring to the operating position.



Stop, in the fixed position.



Always wear approved protective gloves.

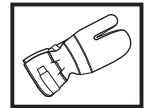

Regular cleaning is required.

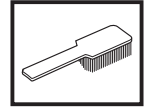

Visual check.

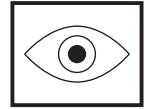

Protective goggles or a visor must be worn.



**Other symbols/decals on the machine refer to special certification requirements for certain markets.**

---

# CONTENTS

---

## Contents

### KEY TO SYMBOLS

Symbols on the machine: ..... 2

Symbols in the operator's manual: ..... 2

### CONTENTS

Contents ..... 3

### WHAT IS WHAT?

What is what on the diamond chain saw? ..... 4

### SAFETY INSTRUCTIONS

Before using a new diamond chain saw ..... 5

Personal protective equipment ..... 5

General safety precautions ..... 6

Machine's safety equipment ..... 7

Checking, maintaining and servicing the machine's  
safety equipment ..... 8

General working instructions ..... 9

### ASSEMBLY

How to tension the chain ..... 13

How to change the chain and rim ..... 14

Tightening the bar nut ..... 15

### FUEL HANDLING

Fuel ..... 16

Fueling ..... 16

### STARTING AND STOPPING

Before starting ..... 17

Starting ..... 17

### MAINTENANCE

Carburetor ..... 18

Fuel filter ..... 18

Air filter ..... 18

Starter ..... 19

Spark plug ..... 20

Cooling system ..... 21

Muffler ..... 21

General maintenance instructions ..... 21

### TECHNICAL DATA

Cutting equipment ..... 22

### FEDERAL EMISSION CONTROL WARRANTY STATEMENT

YOUR WARRANTY RIGHTS AND OBLIGATIONS ..... 23

# WHAT IS WHAT?

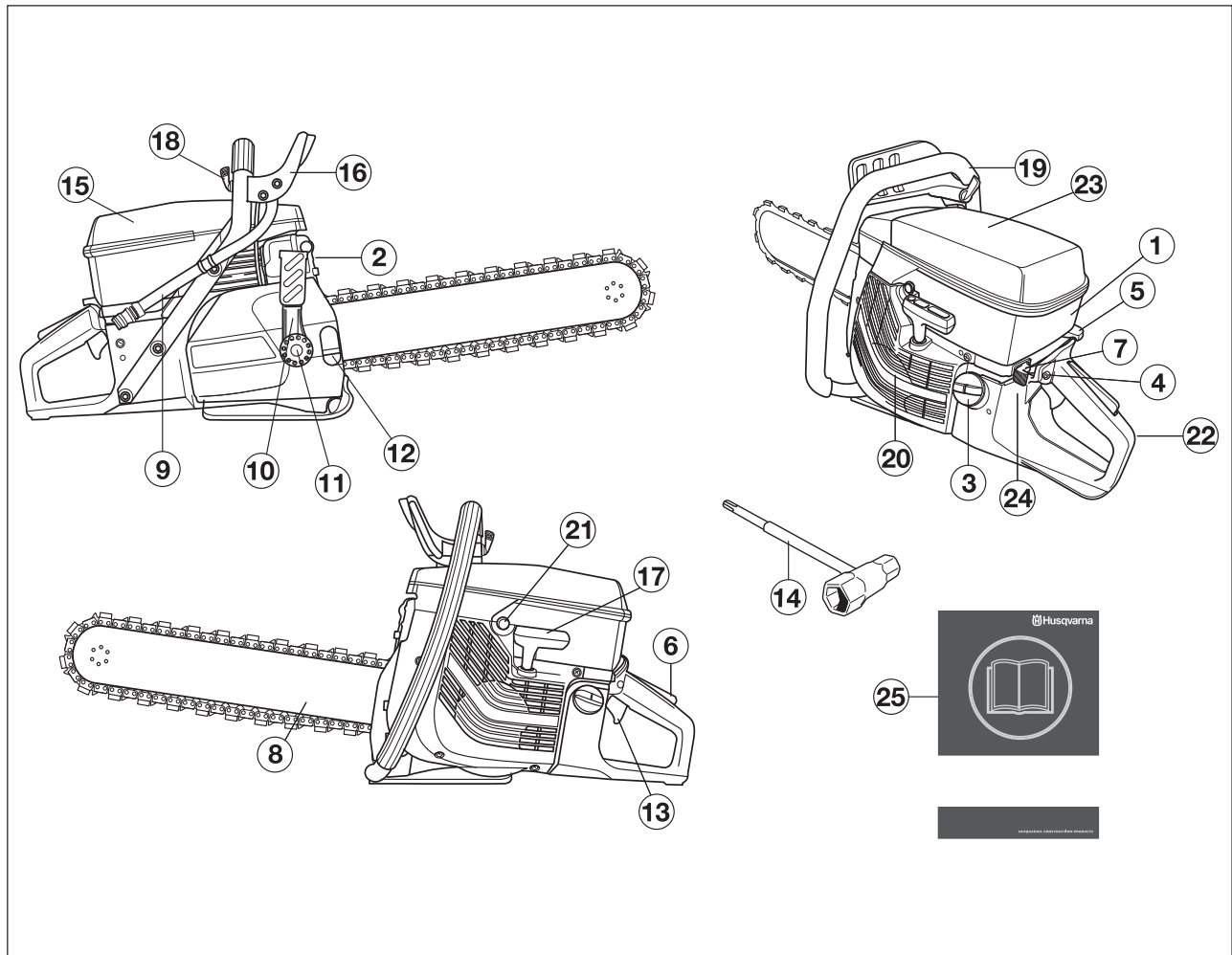

## What is what on the diamond chain saw?

- |                           |                        |
|---------------------------|------------------------|
| 1 Cylinder cover          | 14 Combination spanner |
| 2 Muffler                 | 15 Air filter cover    |
| 3 Fuel tank               | 16 Hand guard          |
| 4 Start throttle lock     | 17 Starter handle      |
| 5 Choke                   | 18 Water tap           |
| 6 Throttle lockout        | 19 Front handle        |
| 7 Stop switch             | 20 Starter             |
| 8 Bar and chain           | 21 Decompression valve |
| 9 Water connector         | 22 Rear handle         |
| 10 Chain tensioner handle | 23 Warning decal       |
| 11 Bar nut                | 24 Type plate          |
| 12 Counter screw          | 25 Operator's manual   |
| 13 Throttle control       |                        |

# SAFETY INSTRUCTIONS

## Before using a new diamond chain saw

- Please read the operator's manual carefully.
- Check the assembly and adjustment of the diamond chain, see chapter "Assembly".
- Start the engine and check the carburettor setting, see chapter "Maintenance", section "Carburettor". If the carburettor setting is correct, the diamond chain shall stand still at idle speed. Setting of the idle speed is described in the Operator's Manual. Set the correct speed according to these instructions. Do not use the diamond chain saw if the idle speed is not adjusted correctly!
- Let your Husqvarna dealer regularly check the machine and make essential adjustments and repairs.

 **WARNING!** Under no circumstances may the design of the machine be modified without the permission of the manufacturer. Always use genuine accessories. Non-authorized modifications and/or accessories can result in serious personal injury or the death of the operator or others.

 **WARNING!** Use of products which cut, grind, drill, sand or shape material can generate dust and vapors which may contain harmful chemicals. Know the nature of the material being worked on and wear appropriate dust mask or respirator protection.

 **WARNING!** A diamond chain saw is a dangerous tool if used carelessly or incorrectly and can cause serious, even fatal injuries. It is very important that you read and understand the contents of this operator's manual.

 **WARNING!** The ignition system of this machine produces an electromagnetic field during operation. This field may under some circumstances interfere with pacemakers. To reduce the risk of serious or fatal injury, we recommend persons with pacemakers to consult their physician and the pacemaker manufacturer before operating this machine.

Husqvarna Construction Products has a policy of continuous product development. Husqvarna reserves the right to modify the design and appearance of products without prior notice and without further obligation introduce design modifications.

All information and all data in the Operator's Manual were applicable at the time the Operator's Manual was sent to print.

 **WARNING**  
The engine exhaust from this product contains chemical known to the State of California to cause cancer, birth defects or other reproductive harm.

You will find the following labels on your power cutter:



The Emissions Compliance Period referred to on the Emission Compliance label indicates the number of operating hours for which the engine has been shown to meet Federal emissions requirements. Category C = 50 hours, B = 125 hours, and A = 300 hours.

## Personal protective equipment

 **WARNING!** You must use approved personal protective equipment whenever you use the machine. Personal protective equipment cannot eliminate the risk of injury but it will reduce the degree of injury if an accident does happen. Ask your dealer for help in choosing the right equipment.

- Protective helmet
- Hearing protection
- Protective goggles or a visor

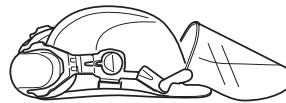

- Breathing mask

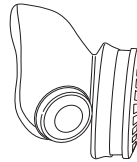

- Heavy-duty, firm grip gloves.



- Tight-fitting, heavy-duty and comfortable clothing that permits full freedom of movement.



# SAFETY INSTRUCTIONS

- Use leg-guards recommended for the material to be cut.
- Boots with steel toe-caps and non-slip sole



- Always have a first aid kit nearby.



## General safety precautions

**IMPORTANT!** Do not use the machine without first reading and understanding the contents of this Operator's Manual. All service over and above the points set out in the chapter "Inspection, maintenance and service of the machine's safety equipment" should be carried out by skilled service personnel.

## Work area safety

- Keep work area clean and well lit. Cluttered or dark areas invite accidents.
- Never use the machine indoors. Be aware of the dangers of inhaling the engine's exhaust fumes.
- Do not use the machine in bad weather, such as dense fog, rain, strong wind, intense cold, etc. Working in bad weather is tiring and often brings added risks, such as icy ground.
- Never start to work with the power cutter before the working area is clear and you have a firm foothold. Look out for any obstacles with unexpected movement. Ensure when cutting that no material can become loose and fall, causing operating injury. Take great care when working on sloping ground.
- Make sure that no pipes or electrical cables are routed in the area to be cut.
- Look around you:
  - To ensure that people, animals or other things cannot affect your control of the machine.
  - To make sure that none of the above come into contact with the diamond chain.



**WARNING!** Only use the machine in areas with good ventilation. Neglect can result in serious injury or death.



**WARNING!** A safe distance from the cut-off saw is 15 metres. You are responsible that animals and onlookers are not in the working area. Do not start to work with the cut-off saw before the working area is clear and you have a firm foothold.

## Personal safety

- Wear personal protective equipment. See instructions under the heading Personal protective equipment.
- Never use the machine if you are tired, if you have drunk alcohol, or if you are taking medication that could affect your vision, your judgement or your co-ordination.
- Never allow anyone else to use the machine without first ensuring that they have understood the contents of the operator's manual.
- Dress properly. Do not wear loose clothing or jewellery. Keep your hair, clothing and gloves away from moving parts. Loose clothes, jewellery or long hair can be caught in moving parts.
- Maintain a safe distance from the cutting chain when the engine is running.
- Always ensure you have a safe and stable working position.



**WARNING!** Overexposure to vibration can lead to circulatory damage or nerve damage in people who have impaired circulation. Contact your doctor if you experience symptoms of overexposure to vibration. These symptoms include numbness, loss of feeling, tingling, pain, loss of strength, changes in skin colour or condition. These symptoms normally appear in the fingers, hands or wrists.

## Use and care

- This machine is designed to cut hard materials, such as masonry. Observe the increased risk of kickback when cutting soft materials. See instructions under the heading How to avoid kickback.
- Never use a machine that is faulty. Carry out the checks, maintenance and service instructions described in this manual. Some maintenance and service measures must be carried out by trained and qualified specialists. See instructions under the heading Maintenance.
- Never use a machine that has been modified in any way from its original specification.
- Do not move the machine when the cutting equipment is rotating.



**WARNING!** Never start the saw without the complete bar and chain fitted.

## Transport and storage

- Store the equipment in a lockable area so that it is out of reach of children and unauthorised persons.
- Store the machine with the chain removed.
- Inspect new cutting equipment for transport and storage damage.

# SAFETY INSTRUCTIONS

## Fuel safety



(Refuelling/Fuel mixture/Storage.)



**WARNING! Take care when handling fuel. Bear in mind the risk of fire, explosion and inhaling fumes.**

- Never refuel the machine while the engine is running.
- Make sure there is plenty of ventilation when refuelling or mixing fuel (gasoline and 2-stroke oil).
- Move the machine at least 10 ft (3 m) from the refuelling point before starting it.

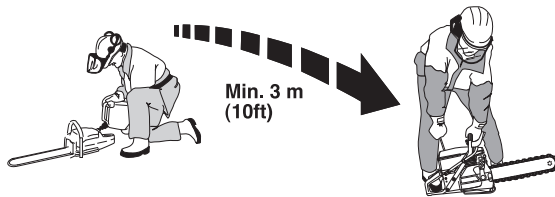

- Never start the machine:
  - If you have spilled fuel on it. Wipe off the spillage and allow remaining fuel to evaporate.
  - If you have spilled fuel on yourself or your clothes, change your clothes. Wash any part of your body that has come in contact with fuel. Use soap and water.
  - If the machine is leaking fuel. Check regularly for leaks from the fuel cap and fuel lines.
- Store and transport the machine and fuel so that there is no risk of any leakage or fumes coming into contact with sparks or naked flames, for example, from electrical machinery, electric motors, electrical relays/switches or boilers.
- Always store fuel in an approved container designed for that purpose.
- When storing the machine for long periods the fuel tank must be emptied. Contact your local gas station to find out where to dispose of excess fuel.
- Always use a Husqvarna fuel container with an anti-spill valve.



**WARNING! Bear in mind the risk of fire, explosion and inhaling fumes. Stop the engine before fuelling. Do not fill so that the fuel runs over. Wipe up all spillage on the ground and machine. If you spill fuel on yourself or your clothes. Change your clothes. Move the machine at least 3 metres away from the refuelling area before starting.**

## Machine's safety equipment

This section describes the machine's safety equipment, its purpose, and how checks and maintenance should be carried out to ensure that it operates correctly. See the "What is what?" section to locate where this equipment is positioned on your machine.



**WARNING! Never use a machine that has faulty safety equipment! Carry out the inspection, maintenance and service routines listed in this section.**

## Vibration damping system

Your machine is equipped with a vibration damping system that is designed to reduce vibration and make operation easier.

The machine's vibration damping system reduces the transfer of vibration between the engine unit/cutting equipment and the machine's handle unit.

The engine body, including the cutting equipment, is insulated from the handles by vibration damping units.

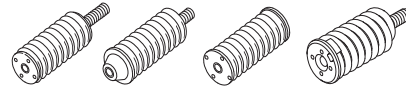

## Stop switch

Use the stop switch to switch off the engine.

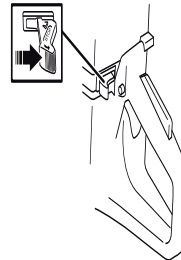

# SAFETY INSTRUCTIONS

## Muffler



**WARNING!** The muffler gets very hot in use and remains so for a short time afterwards. Do not touch the muffler if it is hot!

The muffler is designed to keep noise levels to a minimum and to direct exhaust fumes away from the user.

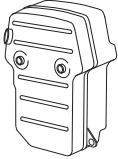

**WARNING!** The exhaust fumes from the engine are hot and may contain sparks which can start a fire. Never start the machine indoors or near combustible material!

**IMPORTANT!** For mufflers it is very important that you follow the instructions on checking, maintaining and servicing your machine. See instructions under the heading Checking, maintaining and servicing the machine's safety equipment.



**WARNING!** The inside of the muffler contain chemicals that may be carcinogenic. Avoid contact with these elements in the event of a damaged muffler.

## Throttle lockout

The throttle trigger lock is designed to prevent accidental operation of the throttle. When the lock (A) is pressed in this releases the throttle (B).

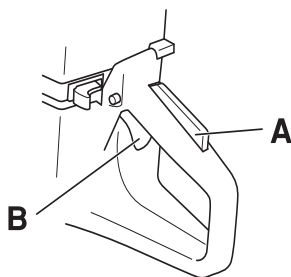

The trigger lock remains pressed in as long as the throttle is pressed. When the grip on the handle is released the throttle trigger and the throttle trigger lock both return to their original positions. This is controlled by two independent return spring systems. This means that the throttle trigger is automatically locked in the idle position.

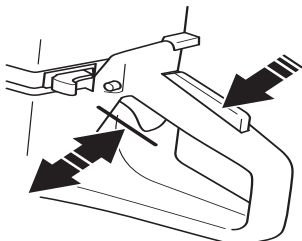

## Checking, maintaining and servicing the machine's safety equipment



**WARNING!** All servicing and repair work on the machine requires special training. This is especially true of the machine's safety equipment. If your machine fails any of the checks described below you must contact your service agent. When you buy any of our products we guarantee the availability of professional repairs and service. If the retailer who sells your machine is not a servicing dealer, ask him for the address of your nearest service agent.

## Vibration damping system



Regularly check the vibration damping units for cracks or deformation.

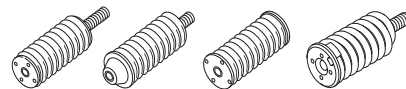

Make sure the vibration damping units are securely attached to the engine unit and handle unit.

## Stop switch

Start the engine and make sure the engine stops when you move the stop switch to the stop setting.

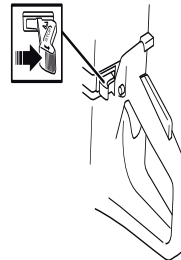

## Muffler

Never use a machine that has a faulty muffler.



Regularly check that the muffler is securely attached to the machine.

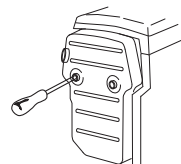

# SAFETY INSTRUCTIONS

## Throttle lockout

- Make sure the throttle control is locked at the idle setting when the throttle lockout is released.

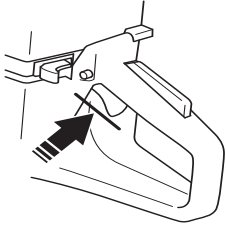

- Press the throttle lockout and make sure it returns to its original position when you release it.

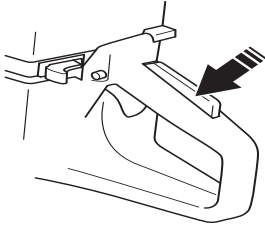

- Check that the throttle control and throttle lockout move freely and that the return springs work properly.

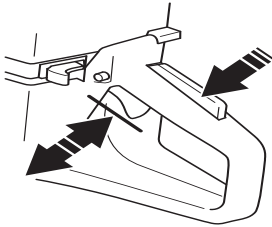

- Start the diamond chain saw and apply full throttle. Release the throttle control and check that the chain stops and remains stationary. If the chain rotates when the throttle control is in the "IDLE POSITION" you should check the carburettor's "IDLE ADJUSTMENT". See instructions under the heading Maintenance.

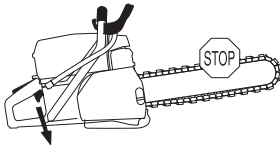

## General working instructions



**WARNING!** This section describes basic safety directions for using the machine. This information is never a substitute for professional skills and experience. If you get into a situation where you feel unsafe, stop and seek expert advice. Contact your dealer, service agent or an experienced power cutter user. Do not attempt any task that you feel unsure of!

## Water cooling

Water cooling must always be used. Dry cutting causes immediate overheating and bar and chain failure with a risk of personal injury.

In addition to cooling the bar and chain, the flow of water pushes particles away from the bar and the drive links. As a result it is important with a high water pressure. The water pressure should be at least 2.5 bar and a maximum of 11 bar. The recommended pressure is approx. 5 bar.



**WARNING!** Water cooling, which is used when cutting concrete, cools the blade and increases its service life while also reducing the formation of dust. Disadvantages include difficulties at very low temperatures, the risk of damaging floors and other structural elements, and the risk of slipping.

## Cutting technique

The technique described below is of a general character.

- Support the work piece in such a way that it is possible to predict what will happen, and so that the cut remains open while cutting.

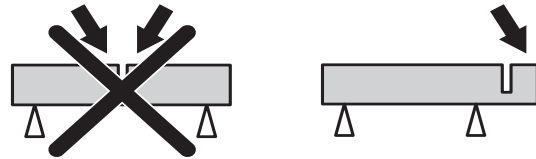

- Always hold the machine in a firm grip with both hands. Hold it so that the thumbs and fingers grip round the handles.
- Start cutting with the machine running at maximum speed.
- Start cutting gently, do not force or squeeze the chain in. Always cut at maximum speed.
- Under normal conditions the machine should run at full throttle. The feed pressure is adjusted so that the speed drops to approx. 20–30 % under maximum speed; this gives the best cutting efficiency and economy.

# SAFETY INSTRUCTIONS

- Move the saw slowly backwards and forwards.

Generally you should attempt to get the chain to cut over distances that are as small as possible. The partial pressure will then be higher and the cutting process will then be faster.

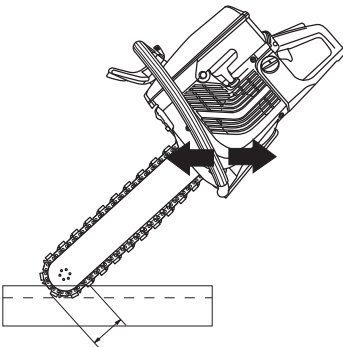
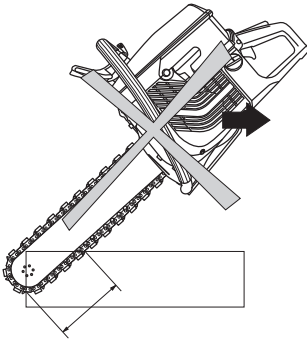

**WARNING!** Under all circumstances avoid cutting using the side of the chain; it will almost certainly be damaged, break and can cause immense damage. Only use the cutting section.

**Do not lean the saw to the side, this can cause the chain to jam or break with personal injury as a consequence.**

In principle there are two ways to start the process of entering a thick object to be cut.

## Plunge-cut method

Start by making a 10 centimetre deep cut in the wall using the lower part of the tip of the bar. Straighten up the saw at the same time as the tip of the bar is inserted in the slot. Raising and lowering the saw at the same time as it is pressed into the wall provides an effective method of cutting to the full depth.

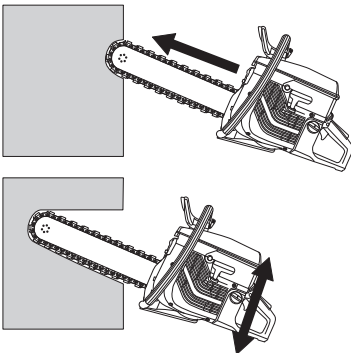

## Pilot method

This method is recommended when attempting to cut absolutely straight and square.

For best cutting economy, pre-cut with a power cutter equipped with Husqvarna's special pre-cutting blade intended for further cutting with diamond chain saw.



**WARNING!** Never use a power cutter with a standard cutting blade for pilot cutting. The cutting blade produces a pilot slot that is too thin and continued cutting with the diamond chain saw results infallibly in dangerous kickback and jamming in the slot.

Start by securing a board where the cut is to be made. This serves as a guide for the cut. Cut to a depth of a few centimetres along the entire line, using the lower section of the tip of the bar. Go back and cut another few centimetres. Repeat until a depth of between 5–10 centimetres is reached, depending on precision demands and the thickness of the object. The pilot cut guides the bar straight during continued cutting, which takes place according to the plunge-cut method until full depth is reached, use a rubber block as a break point/stop.

## Pendulum technique

The cut is made using a pendulum motion and the saw is only held straight at the ends of the cut.

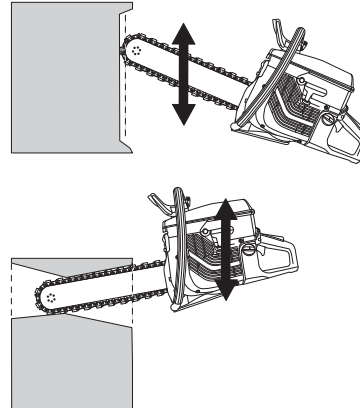

## Safety instructions while working

Plan the work so that you do not get crushed by the bar when the pieces fall apart. Planning is also extremely important for your own safety!

As it is usually a question of large and heavy pieces that are cut when using the diamond chain saw the forces are so great that jamming can result in irreparable damage to both the bar and chain.

Support the work piece in such a way that it is possible to predict what will happen, and so that the cut remains open while cutting. In those cases where it is difficult to calculate how the pieces will fall apart, or when it is impossible to support the workpiece as you would like, wedging in the cut slot is a good and safe method.

# SAFETY INSTRUCTIONS

## Cutting holes

A common task for the diamond chain saw is making small openings in thick walls. First make the lower horizontal cut. Now make the two vertical cuts. Finish with the upper horizontal cut. The risk of jamming is then avoided.

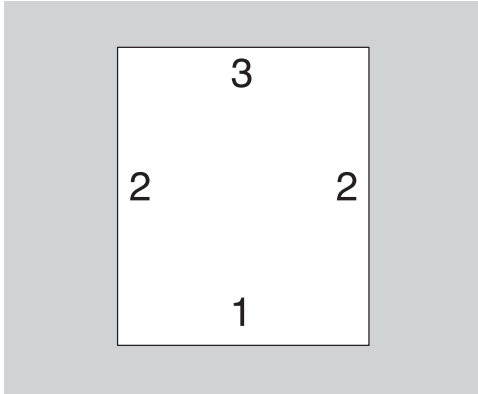

## Bracing

When cutting out large holes it is important that the piece to be cut out is braced so that it cannot fall against the operator.

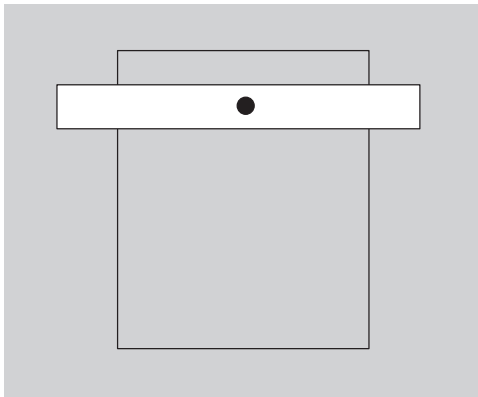

## How to avoid kickback



**WARNING!** Kickback can happen very suddenly and violently; kicking the power cutter and cutting blade back at the user. If this happens when the cutting blade is moving it can cause very serious, even fatal injuries. It is vital you understand what causes kickback and that you can avoid it by taking care and using the right working technique.

## What is kickback?

The word kickback is used to describe the sudden reaction that causes the power cutter and cutting blade to be thrown from an object when the upper quadrant of the blade, known as the kickback zone, touches an object.

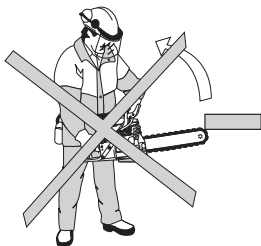

## General rules

- Never start to cut with the upper quadrant of the blade as shown in the figure, also known as the kickback zone.

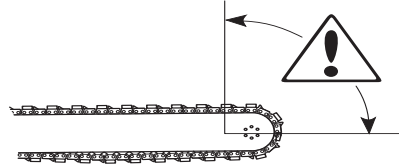

- Always hold the machine in a firm grip with both hands. Hold it so that the thumbs and fingers grip round the handles.
- Keep a good balance and a firm foothold.
- Always cut at maximum speed.
- Stand at a comfortable distance from the work piece.
- Take care when inserting the blade in an existing cut.
- Never cut above shoulder height.
- Be alert to movement of the work piece or anything else that can occur, which could cause the cut to close and pinch the blade.

## Pull in

Pull in occurs when the disc's lower section suddenly stops or when the cut closes. (To avoid, see the heading "Basic rules" and "Jamming/rotation", here below.)

## Pinching/rotation

If the cut is pressed together this can lead to jamming. The machine can be pulled down suddenly with a very powerful jerk.

## How to avoid pinching

Support the work piece in such a way that the cut remains open during the cutting operation and when the cut is finished.

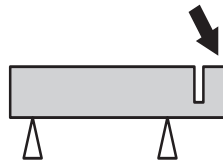

# SAFETY INSTRUCTIONS

## Diamond chains



**WARNING! Chain breakage can result in serious injury if the chain is thrown towards the operator.**

There are two basic types of diamond chain available on the market.

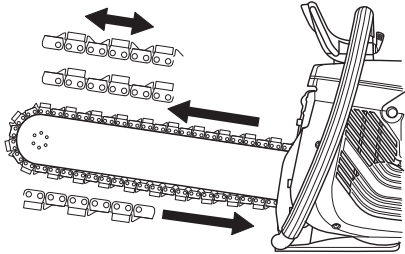

When using a chain with double rakers, the chain can be fitted either way round. When using a chain with one raker, the chain should always be fitted the right way round. The raker should guide the segment at the right height in the cut.

**IMPORTANT!** If the chain has been used and is refitted it must be fitted in the same working direction as earlier in order to reduce segment wear and to obtain full cutting capacity directly.

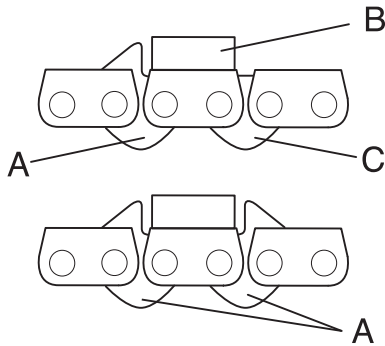

A) Drive link with raker

B) Cutting link with diamond segment

C - Drive link without washer

## Check the chain

Check that the chain does not show signs of damage in the form of play on the links, broken raker or drive links or broken segments.

If the chain has been exposed to hard jamming or other abnormal overloading, the chain should be dismantled from the bar for careful inspection.

## Fit the chain the right way round

The chain must never be fitted the wrong way round. The raker should guide the segment at the right height in the cut.

## Check the saw

The saw is equipped with a number of safety features that protect the operator in the event of chain breakage. These safety features must be checked before work starts. Never use the saw if any of the following parts are damaged or missing:

- Cover over drive gear
- Damaged or missing hand guard
- Damaged chain

## Use the saw the right way up

For reasons of safety the saw must never be used upside down. Parts worn loose from the cut object or damaged chain parts can be thrown towards the operator.

## Material

This machine is designed for and intended for cutting concrete, brick and different stone materials. All other use is improper.

The saw must never be used to cut pure metals. This will probably result in broken segments or chain breakage. The diamond segment can cut reinforced concrete. Try to cut the reinforcement together with as much concrete as possible, this will save the chain.

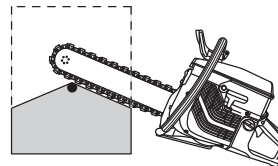
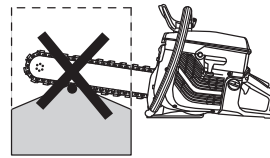

## Glazing

After cutting extremely hard concrete or stone the diamond segment may lose some or all of its cutting capacity. This can also occur if you are forced to cut with a low partial pressure (the diamond chain runs against the workpiece along the entire length of the bar). The solution to the problem is to cut in a soft abrasive material such as sandstone or brick, for a short while.



**WARNING! Under no circumstances may the diamond chain saw be converted to cut other materials than those it is intended for. It must never be equipped with a timber saw chain.**

# ASSEMBLY

## How to tension the chain

If the play between drive link and bar is bigger than 12 mm, the chain is too loose and must be tightened.

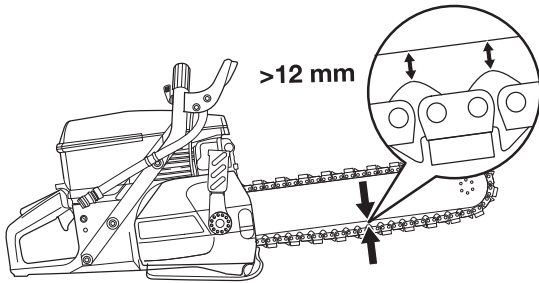

Opening the adjust screw cover.

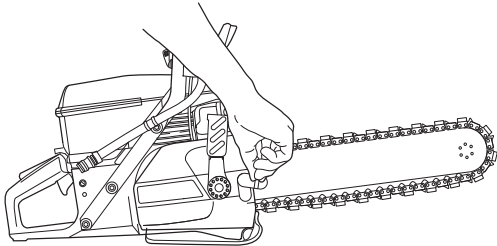

Pull the handle backwards.

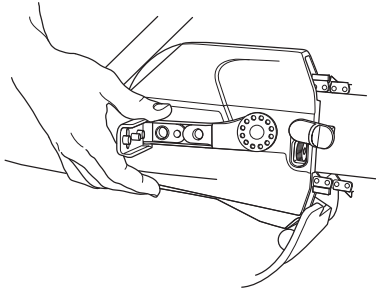

Continue to move the handle down-wards until you start to tension the chain.

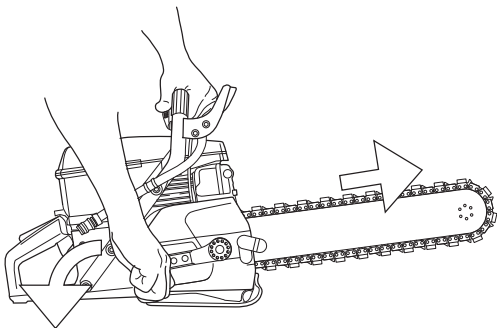
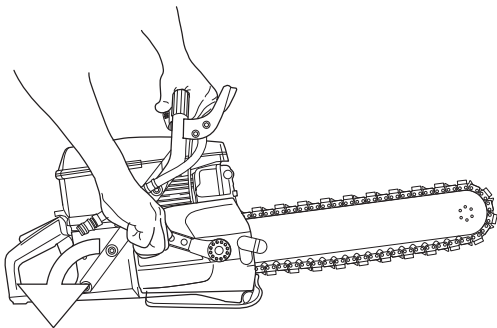

Hold the bar upwards as you move the handle forward.

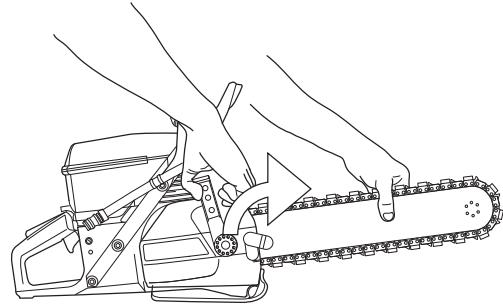

Lock the chain tension by tightening the counter screw.

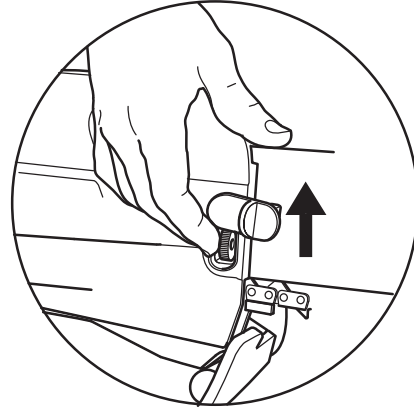

Close the adjust screw cover.

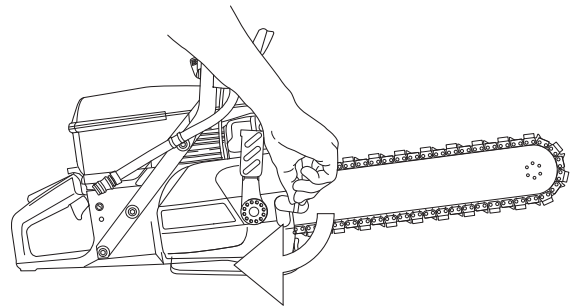

### NOTE!

A correctly tightened chain should be easy to pull around by hand.

# ASSEMBLY

## How to change the chain and rim

Pull the handle backwards.

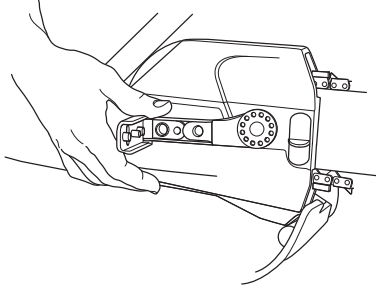

Press the spring down on the chain tensioner handle. Unscrew the adjusting bar nut anti-clockwise.

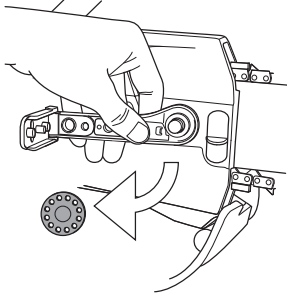

Remove the cover.

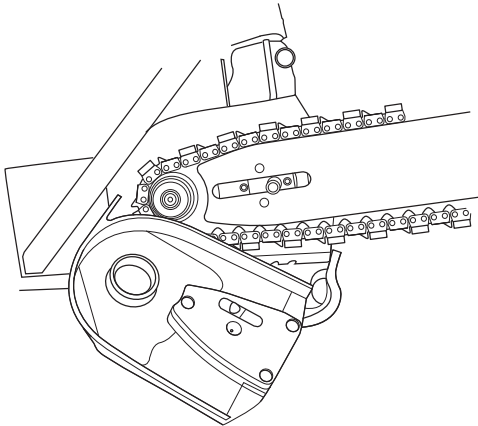

Remove the bar and chain.

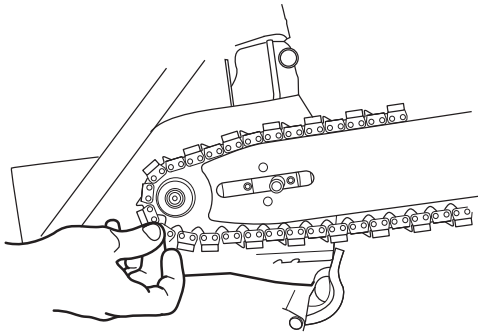

Remove the spring holding the two "half-moons" using a screwdriver.

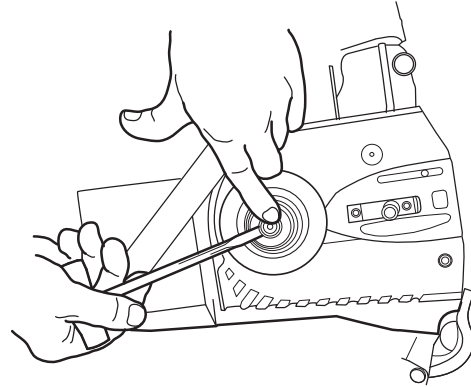

Remove the "halfmoons", the cup guard, o-ring and the drive sprocket.

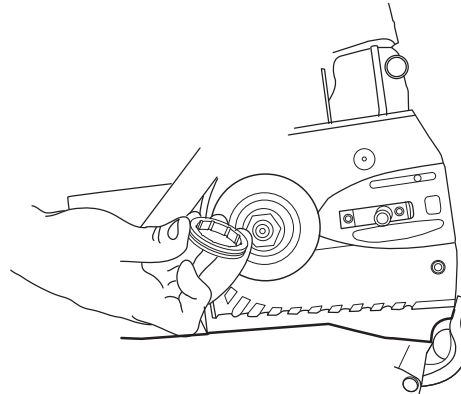

Assemble the parts in the reverse order.

**IMPORTANT!** During all reassembling, make sure that the outer cover fits in to the inner cover, the covers may be damaged otherwise.

Make sure that the chain adjuster pin fits into the hole on the bar.

Turn the bar when replacing the chain for maximum bar life.

---

# ASSEMBLY

---

## Tightening the bar nut

If the bar and chain tensioner handle feel loose, the bar nut must be tightened to achieve the correct tension moment in the nut. This so that the bar does not fit loosely.

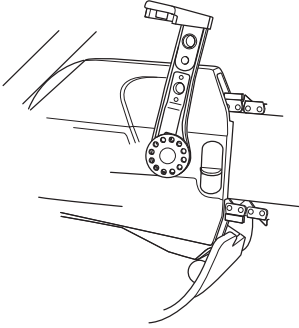

Move the lever to its rear, lower position. Push in the spring on the chain tensioner handle and turn the bar nut clockwise by hand.

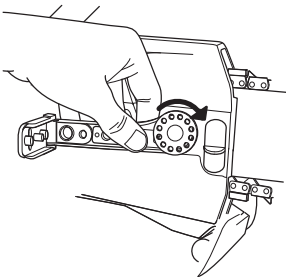

Release the spring. Hold the bar upwards as you move the handle forward. Note that the arm's mechanical stop shall not be reached. The stop prevents the arm from pointing forwards and prevents cutting.

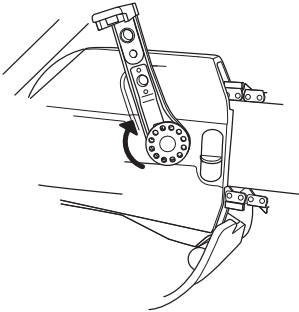

# FUEL HANDLING

## Fuel

CAUTION! The machine is equipped with a two-stroke engine and must always be run using a mixture of gasoline and two-stroke engine oil. It is important to accurately measure the amount of oil to be mixed to ensure that the correct mixture is obtained. When mixing small amounts of fuel, even small inaccuracies can drastically affect the ratio of the mixture.



**WARNING! Always ensure there is adequate ventilation when handling fuel.**

**Do not use the machine unless you are able to call for help in the event of an accident.**

## Gasoline

- The lowest recommended octane grade is 87 ((RON+MON)/2). If you run the engine on a lower octane grade than 87 so-called knocking can occur. This gives rise to a high engine temperature and increased bearing load, which can result in serious engine damage.

## Two-stroke oil

- For best results and performance use HUSQVARNA two-stroke engine oil, which is specially formulated for our air-cooled two stroke-engines.
- Never use two-stroke oil intended for water-cooled engines, sometimes referred to as outboard oil (rated TCW).
- Never use oil intended for four-stroke engines.

## Mixing ratio

1:50 (2%) for all engines.

Gasoline, litre	Two-stroke oil, litre
	<b>2% (1:50)</b>
5	0,10
10	0,20
15	0,30
20	0,40
US gallon	US fl. oz.
1	2 1/2
2 1/2	6 1/2
5	12 7/8

## Mixing

- Always mix the gasoline and oil in a clean container intended for fuel.
- Always start by filling half the amount of the gasoline to be used. Then add the entire amount of oil. Mix (shake) the fuel mixture. Add the remaining amount of gasoline.

- Mix (shake) the fuel mixture thoroughly before filling the machine's fuel tank.



- Do not mix more than one month's supply of fuel at a time.
- If the machine is not used for some time the fuel tank should be emptied and cleaned.

## Fueling



**WARNING! Taking the following precautions, will lessen the risk of fire:**

**Do not smoke or place hot objects near fuel.**

**Always shut off the engine before refuelling.**

**When refuelling, open the fuel cap slowly so that any excess pressure is released gently.**

**Tighten the fuel cap carefully after refuelling.**

**Always move the machine away from the refuelling area before starting.**

- Keep the handle dry and free from oil and fuel.
- Ensure that the fuel is well mixed by shaking the container before filling the tank.

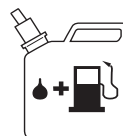

- Always exercise care when refilling the fuel. Move the machine at least three metres from the fuelling area before it is started. Check that the fuel cap is tightened correctly.

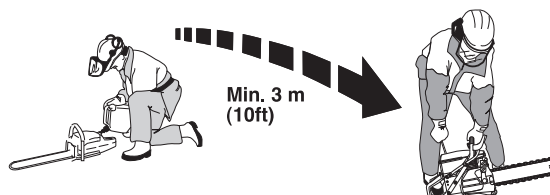

- Clean around the fuel cap. Clean the fuel and oil tank regularly. The fuel filter should be changed at least once a year. Contamination in the tanks causes malfunction.

# STARTING AND STOPPING

## Before starting



**WARNING!** Note the following before starting:

Do not start the power cutter without the belt guard fitted. Otherwise the clutch could come loose and cause personal injuries.

Always move the machine away from the refuelling area before starting.

Ensure that you and the machine have a good working stance and that the cutting blade can rotate freely.

Keep people and animals well away from the working area.

**Decompression valve:** Press the valve to reduce the compression in the cylinder. The decompression valve should always be used when starting. The valve automatically returns to its initial position when the machine starts.

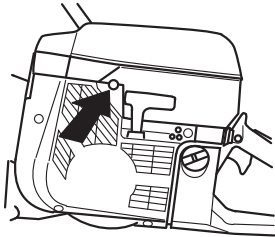

**Stop switch:** Make sure that the stop switch (STOP) is in the left position.

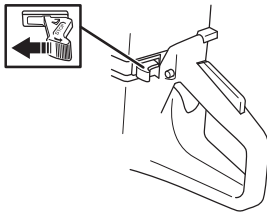

**Start throttle position - cold engine:** Start throttle position and choke is obtained by pulling out the choke completely.

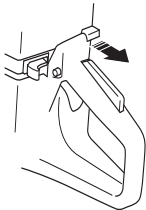

**Start throttle position - warm engine:** The correct choke/start throttle setting is obtained by pulling the choke control to the choke position and then pushing it in again. This only engages the start throttle setting without any choke.

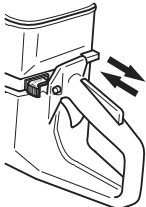

## Starting

Grip the front handle with your left hand. Put your right foot on the lower section of the rear handle pressing the machine against the ground. **Never wrap the starter cord around your hand**

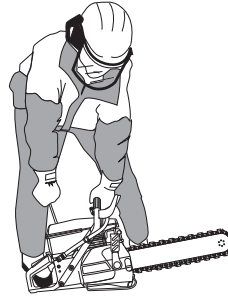

**WARNING!** The cutting blade rotates when the engine is started. Make sure it can rotate freely.

Grip the starter handle, slowly pull out the cord with your right hand until you feel some resistance (the starter pawls grip), now quickly and powerfully pull the cord.

**CAUTION!** Do not pull the starter cord all the way out and do not let go of the starter handle when the cord is fully extended. This can damage the machine.

With a cold engine: Push in the choke control as soon as the engine fires and make repeated starting attempts.

When the engine starts, quickly apply full throttle to automatically disengage fast idle.

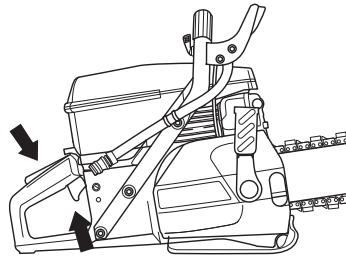

## Stopping

Stop the engine by moving the stop switch (STOP) to the right.

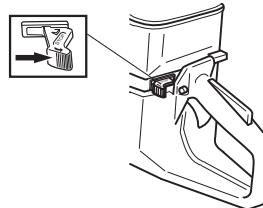

# MAINTENANCE

## Carburetor

Your Husqvarna product has been designed and manufactured to specifications that reduce harmful emissions. After the engine has used 8-10 tanks of fuel the engine will be run-in. To ensure that it continues to run at peak performance and to minimise harmful exhaust emissions after the running-in period, ask your dealer/service workshop (who will have a rev counter at their disposal) to adjust your carburettor.

### Function

- The carburettor governs the engine speed via the throttle. Air and fuel are mixed in the carburettor.

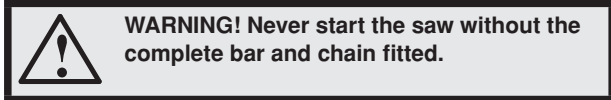

### Needles

The carburettor is equipped with fixed needles to ensure the machine always receives the correct mixture of fuel and air. When the engine lacks power or accelerates poorly, do the following:

- Check the air filter and replace if necessary.
- When this does not help, contact an authorised service workshop.

### Fine adjustment of the idle speed T

Adjust the idle speed using the T screw. Turn the idle speed screw clockwise until the chain starts to rotate. Now turn the screw anti-clockwise until the chain stops rotating. A correctly adjusted idle speed is set when the engine accelerates without hesitation.

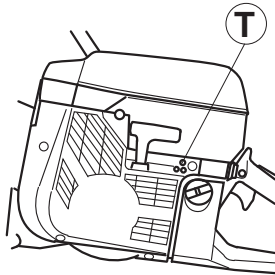

Rec. idle speed: 2700 rpm

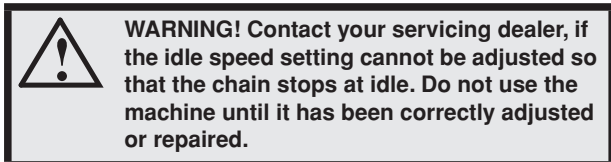

## Fuel filter

- The fuel filter sits inside the fuel tank.
- The fuel tank must be protected from contamination when filling. This reduces the risk of operating disturbances caused by blockage of the fuel filter located inside the tank.
- The filter cannot be cleaned but must be replaced with a new filter when it is clogged. **The filter should be changed at least once per year.**

## Air filter



Air filters must be regularly cleaned to remove dust and dirt in order to avoid:

- Carburettor malfunctions
- Starting problems
- Loss of engine power
- Unnecessary wear to engine parts
- Excessive fuel consumption.

The air filter system consists of an oiled foam plastic filter (1) and a paper filter (2):

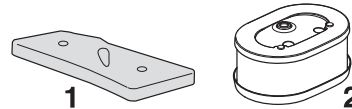

- 1 The foam plastic filter is easily accessible under the filter cover A. This filter should be checked weekly and replaced if necessary. In order to obtain a good filtering effect, the filter must be replaced regularly or cleaned and oiled. A special HUSQVARNA oil has been produced for this purpose.

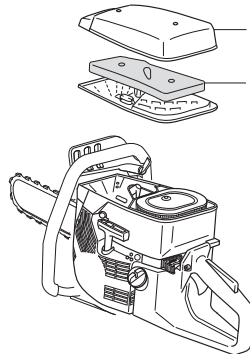

Remove the foam plastic filter. Wash the filter well in tepid soapy water. After cleaning, rinse the filter well in clean water. Squeeze out and allow the filter to dry. **NOTE!** High pressure compressed air can damage the foam.



# MAINTENANCE

Put the filter in a plastic bag and pour the filter oil over it. Knead the plastic bag to distribute the oil. Squeeze the excess oil out of the filter inside the plastic bag and pour off the excess before fitting the filter to the machine. Never use common engine oil. This would drain through the filter quite quickly and collect in the bottom.

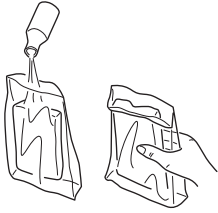

- The paper filter is accessible under cover B. This filter must be replaced/cleaned when the engine's power drops. The filter is cleaned by shaking. Note that the filter must not be washed. NOTE! High pressure compressed air can damage the filter.



An air filter that has been in use for a long time cannot be cleaned completely. The filter must therefore be replaced with a new one at regular intervals. **A damaged air filter must always be replaced.**

## IMPORTANT INFORMATION

Poor maintenance of the air filter will cause carbon build-up on the spark plug and abnormal wear to engine parts.

## Starter



**WARNING!** When the recoil spring is wound up in the starter housing it is under tension and can, if handled carelessly, pop out and cause personal injury.

Always be careful when changing the recoil spring or the starter cord. Always wear protective goggles.

## Changing a broken or worn starter cord



- Loosen the screws that hold the starter against the crankcase and remove the starter.

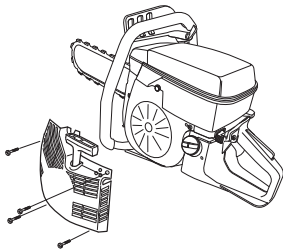

- Pull out the cord approx. 30 cm (12 inches) and hook it into the notch in the rim of the pulley. Release the recoil spring by letting the pulley rotate slowly backwards.

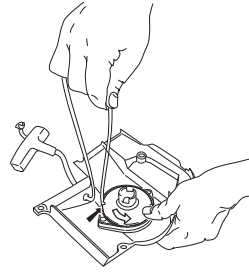

- Remove any remnants of the old starter cord and check that the return spring works. Insert the new starter cord through the hole in the starter housing and in the cord pulley.

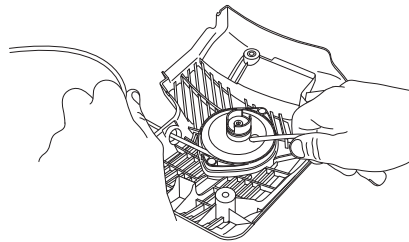

- Secure the starter cord around the cord pulley as illustrated. Tighten the fastening well and ensure that the free end is as short as possible. Secure the end of the starter cord in the starter handle.

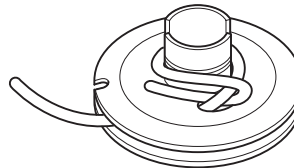

- Guide the cord through the cut-out in the periphery of the pulley and wind the cord 3 times clockwise around the centre of the starter pulley.

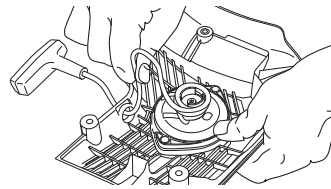

- Now pull the starter handle and in doing so tension the spring. Repeat the procedure once more, but this time with four turns.
- Note that the starter handle is drawn to its correct home position after tensioning the spring.
- Check that the spring is not drawn to its end position by pulling out the starter line fully. Slow the starter pulley with your thumb and check that you can turn the pulley at least a further half turn.

# MAINTENANCE

## Tensioning the recoil spring

- Hook the starter cord in the notch in the pulley and turn the starter pulley about 2 turns clockwise.

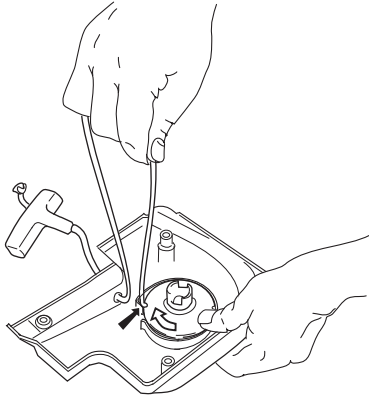

**CAUTION!** Check that the pulley can be turned an additional 1/2 turn when the starter cord is pulled all the way out.

## Changing a broken recoil spring



- Undo the bolt in the centre of the pulley and remove the pulley.
- Bear in mind that the return spring lies tensioned in the starter housing.
- Loosen the bolts holding the spring cassette.

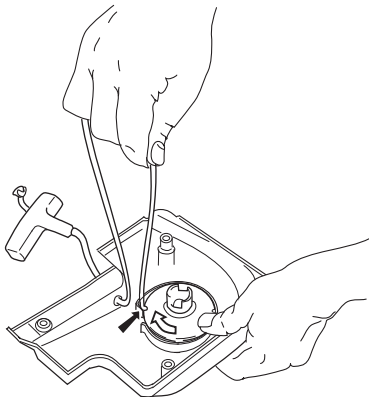

- Lubricate the recoil spring with light oil. Fit the pulley and tension the recoil spring.

## Fitting the starter

- To fit the starter, first pull out the starter cord and place the starter in position against the crankcase. Then slowly release the starter cord so that the pulley engages with the pawls.

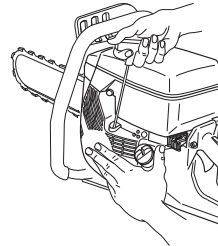

- Fit and tighten the screws that hold the starter.

## Spark plug



The spark plug condition is influenced by:

- Incorrect carburetor adjustment.
- Wrong fuel mixture (too much oil).
- A dirty air filter.

These factors cause deposits on the spark plug electrodes, which may result in operating problems and starting difficulties.

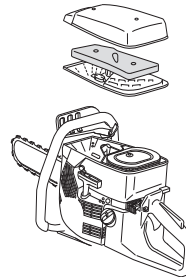

- If the machine is low on power, difficult to start or runs poorly at idle speed: always check the spark plug first before taking any further action. If the spark plug is dirty, clean it and check that the electrode gap is 0.020 inch (0.5 mm). The spark plug should be replaced after about a month in operation or earlier if necessary.

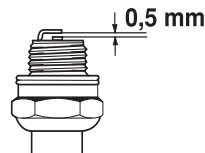

**CAUTION!** Always use the recommended spark plug type! Use of the wrong spark plug can damage the piston/cylinder.

# MAINTENANCE

## Cooling system

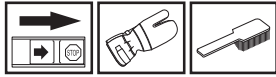

To keep the working temperature as low as possible the machine is equipped with a cooling system.

The cooling system consists of:

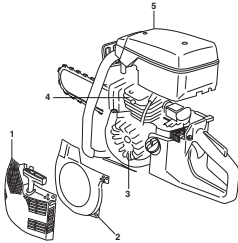

- 1 Air intake on the starter.
- 2 Air guide plate.
- 3 Fins on the flywheel.
- 4 Cooling fins on the cylinder.
- 5 Cylinder cover

Clean the cooling system with a brush once a week, more often in demanding conditions. A dirty or blocked cooling system results in the machine overheating which causes damage to the piston and cylinder.

## Muffler

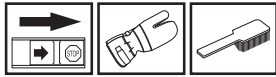

The muffler is designed to reduce the noise level and to direct the exhaust gases away from the operator. The exhaust gases are hot and can contain sparks, which may cause fire if directed against dry and combustible material.

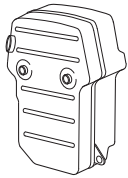

Never use a machine with a defective muffler.

## General maintenance instructions

Below you will find some general maintenance instructions. If you have more questions, contact your service agent.

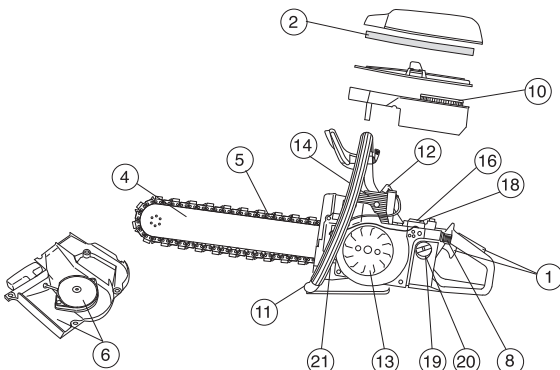

## Daily maintenance

- 1 Check that the components of the throttle control work smoothly (throttle control and throttle trigger lock).
- 2 Check the bar tip sprocket.
- 3 Check the condition of the bar.
- 4 Check the condition of the diamond chain.
- 5 Check, clean or replace the main filter.
- 6 Check the starter and starter cord and clean the outside of the starter unit's air intake.
- 7 Check that nuts and screws are tight.
- 8 Check that the stop switch works correctly.
- 9 Grease chain, bar tip sprocket and bar to prevent corrosion.

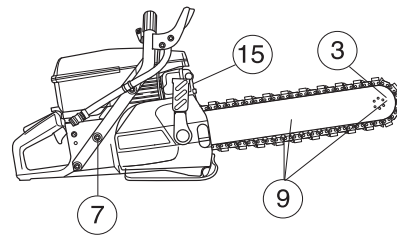

## Weekly maintenance

- 10 Check the paper filter.
- 11 Check that the handles and vibration damping elements are not damaged.
- 12 Clean the spark plug. Check that the electrode gap is 0.020 inch (0.5 mm).
- 13 Clean the fins on the flywheel. Check the starter and the recoil spring.
- 14 Clean the cooling fins on the cylinder.
- 15 Check that the muffler is securely attached and not damaged.
- 16 Check the operation of the carburettor.

## Monthly maintenance

- 17 Check the clutch centre, drive gear and clutch spring for wear.

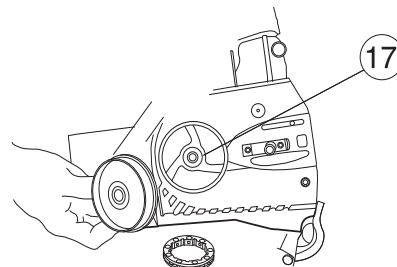

- 18 Clean the outside of the carburetor.
- 19 Check fuel hose for cracks or other damage. Change if necessary.
- 20 Clean the inside of the fuel tank.
- 21 Check all cables and connections.

---

# TECHNICAL DATA

---

## Motor

Cylinder displacement, cu.in/cm <sup>3</sup>	5,7/93,6
Cylinder bore, inch/mm	56
Stroke, inch/mm	38
Idle speed, rpm	2700
Recommended max. speed, rpm	9750 (+/- 250)
Power, kW/ rpm	4,5/9000

## Ignition system

Manufacturer of ignition system	SEM
Type of ignition system	CD
Spark plug	Champion RCJ 6Y/ NGK BPMR 7A
Electrode gap, inch/mm	0,02/0,5

## Fuel and lubrication system

Manufacturer of carburetor	Walbro
Carburetor type	RWJ-3A
Fuel tank capacity, US pint/litre	1,0

## Weight

Weight without fuel and cutting attachment, kg	20,7/9,4
--	----------

## Cutting equipment

<b>Bar and diamond chain</b>	<b>Chain speed at max. power, m/sec</b>
14"	28



# FEDERAL EMISSION CONTROL WARRANTY STATEMENT

## YOUR WARRANTY RIGHTS AND OBLIGATIONS

The EPA (The US Environmental Protection Agency), Environment Canada and Husqvarna Construction Products are pleased to explain the emissions control system warranty on your 2001 and later small nonroad engine. In U.S. and Canada, new small nonroad engines must be designed, built and equipped to meet the federal stringent anti-smog standards. Husqvarna Construction Products must warrant the emission control system on your small nonroad engine for the period of time listed below provided there has been no abuse, neglect or improper maintenance of your unit. Your emission control system includes Parts such as the carburetor and the ignition system. Where a warrantable condition exists, Husqvarna Construction Products will repair your small nonroad engine at no cost to you. Expenses covered under warranty include diagnosis, parts and labor.

## MANUFACTURER'S WARRANTY COVERAGE

The 2001 and later small nonroad engines are warranted for two years. If any emission related part on you engine (as listed above) is defective, the part will be repaired or replaced by Husqvarna Construction Products.

## OWNER'S WARRANTY RESPONSIBILITIES

As the small nonroad engine owner, you are responsible for the performance of the required maintenance listed in your Operator's Manual. Husqvarna Construction Products recommends that you retain all receipts covering maintenance on your small nonroad engine, but Husqvarna Construction Products cannot deny warranty solely for the lack of receipts or for your failure to ensure the performance of all scheduled maintenance. As the small nonroad engine owner, you should, however, be aware that Husqvarna Construction Products may deny you warranty coverage if your small nonroad engine or a part of it has failed due to abuse, neglect, improper maintenance, unapproved modifications or the use of parts not made or approved by the original equipment manufacturer. You are responsible for presenting your small nonroad engine to a Husqvarna Construction Products authorized servicing dealer as soon as a problem exists. The warranty repairs should be completed in a reasonable amount of time, not to exceed 30 days. If you have any questions regarding your warranty rights and responsibilities, you should contact your nearest authorized servicing dealer or call Husqvarna Construction Products, at 1-800-323 3553.

## WARRANTY COMMENCEMENT DATE

The warranty period begins on the date small nonroad engine is delivered.

## LENGTH OF COVERAGE

Husqvarna Construction Products warrants to the initial owner and each subsequent purchaser that the engine is free from defects in materials and workmanship which cause the failure of a warranted part for a period of two years.

## WHAT IS COVERED

**REPAIR OR REPLACEMENT OF PARTS** Repair or replacement of any warranted part will be performed at no charge to the owner at an approved Husqvarna Construction Products servicing dealer. If you have any questions

regarding your warranty rights and responsibilities, you should contact your nearest authorized servicing dealer or call Husqvarna Construction Products, at 1-800-323 3553.

**WARRANTY PERIOD** Any warranted part which is not scheduled for replacement as required maintenance, or which is scheduled only for regular inspection to the effect of "repair or replace as necessary" shall be warranted for 2 years. Any warranted part which is scheduled for replacement as required maintenance shall be warranted for the period of time up to the first scheduled replacement point for that part.

**DIAGNOSIS** The owner shall not be charged for diagnostic labor which leads to the determination that a warranted part is defective, if the diagnostic work is performed at an approved Husqvarna Construction Products servicing dealer.

**CONSEQUENTIAL DAMAGES** Husqvarna Construction Products may be liable for damages to other engine components caused by the failure of a warranted part still under warranty.

## WHAT IS NOT COVERED

All failures caused by abuse, neglect or improper maintenance are not covered.

## ADD -ON OR MODIFIED PARTS

The use of add-on or modified parts can be grounds for disallowing a warranty claim. Husqvarna Construction Products is not liable to cover failures of warranted parts caused by the use of add-on or modified parts.

## HOW TO FILE A CLAIM

If you have any questions regarding your warranty rights and responsibilities, you should contact your nearest authorized servicing dealer or call Husqvarna Construction Products, at 1-800-323 3553.

## WHERE TO GET WARRANTY SERVICE

Warranty services or repairs shall be provided at all Husqvarna Construction Products authorized servicing dealers.

## MAINTENANCE, REPLACEMENT AND REPAIR OF EMISSION-RELATED PARTS

Any Husqvarna Construction Products approved replacement part used in the performance of any warranty maintenance or repairs on emission-related parts, will be provided without charge to the owner if the part is under warranty.

## EMISSION CONTROL WARRANTY PARTS LIST

- 1 Carburetor and internal parts
- 2 Intake pipe, airfilter holder and carburetor bolts.
- 3 Airfilter and fuelfilter covered up to maintenance schedule.
- 4 Ignition System
  - 1 Spark Plug, covered up to maintenance schedule
  - 2 Ignition Module

## MAINTENANCE STATEMENT

The owner is responsible for the performance of all required maintenance, as defined in the operator's manual.



**WARNING!** Cutting, especially when DRY cutting, generates dust that comes from the material being cut, which frequently contains silica. Silica is a basic component of sand, quartz, brick clay, granite and numerous other minerals and rocks. Exposure to excessive amount of such dust can cause:

Respiratory disease (affecting your ability to breath), including chronic bronchitis, silicosis and pulmonary fibrosis from exposure to silica. These diseases may be fatal;

Skin irritation and rash.

Cancer according to NTP\* and IARC\*  
\*/ National Toxicology Program, International Agency for Resaearch on Cancer

Take precautionary steps:

Avoid inhalation of and skin contact with dust, mist and fumes.

Wear and ensure that all bystanders wear appropriate respiratory protection such as dust masks designed to filter out microscopic particles. (See OSHA 29 CFR Part 1910.1200)

Wet cut when feasible, to minimize dust.

**Original instructions**

**1153349-95**



**2009-12-29**